

# Djinnang Association

(Qld)



A & GRS

1945-1952



1945-1952



School of Radio

1952-1993

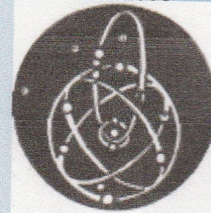

1952-1961

# QTC

**30th**

<sup>H</sup>

*Edition*

**2019**

I HAVE A MESSAGE FOR YOU



**3 Telu**



WEB SITE: <http://www.djinnang.com>



FACEBOOK.COM (LOG ON) SEARCH DJINNANG



**President...Gavin Smith**

**Secretary...Gail McDermott**

**Treasurer...Alwyn Hawkes**

**Committee...Barb Watson, John Isaacs, Tracey Stephens (Facebook).**

**Publications/Newsletter/Emails...Brian Webb**

**Website Mechanic...Kerry Harrington**



RAAF DJINNANG ASSOCIATION -ANNUAL REUNION etc. 2019

PRESIDENT'S REPORT 2018/2019 - AGM 25/ 5 2019

The 2018 Reunion was held at The Hotel Jen and everyone who attended were extremely impressed with the Venue, Snacks etc. Unfortunately we were advised the Roma Street Complex was being demolished and a whole new complex was being built so, back to the Drawing Board for new venue.

The ever energetic Gail McDermott, your hard working Secretary, did the rounds of the CBD and found suitable facilities at the Port Hotel, expenses for the function having being taken into consideration. The Hotel Jen will not be available for approximately 3 to 5 years. Thanks again to Gail and Alyn Hawkes.

During the previous year, we have lost a number of members, mostly SIGOPS, to the big Radio Shack in the sky. To family and friends of those members we pass on our heartfelt condolences. Once again the Committee worked very hard organising the 2018 Reunion and hopefully in the future the Hotel Jen will be available. I thank the Committee members very much to all their efforts.

In conclusion I would like to thank everyone for attending and please pass on the word to our younger generation about our Association.

Regards to everyone and safe journey home.

  
Gavin Smith  
President  
25/5/2019.





**DJINNANG ASSOCIATION (QLD)**  
**INCOME AND EXPENDITURE STATEMENT**  
**1 JUL 2018 TO 30 JUN 2019**

**Statement of Financial Position as at 1 Jul 2018**

BOQ Cheque Account:	\$3,806.54
BOQ Investment Account:	\$9,135.91
<b><u>Balance as at 1 Jul 18</u></b>	<b>\$12,942.45</b>

**Expenditure (CHEQUE ACCOUNT)**

Printing, Stationary & Postage	\$383.33	Incl QTC
Reunion -Port Hotel	\$3,000.00	Food & first drink etc
Reunion - Prizes/stationery/sundries	\$180.00	
Reunion - Float	\$300.00	
<b><u>Total Expenditure:</u></b>	<b>\$3,863.33</b>	
<b>SUB TOTAL</b>	<b>-\$56.79</b>	

**Income (CHEQUE ACCOUNT):**

Membership - yearly	\$620.00
Membership - perpetual	\$200.00
Bank Interest - cheque account	\$4.29
Reunion Cover charge	\$2,210.00
Reunion Raffles	\$325.00
Shirts	\$283.50
Float return	\$300.00
<b>LESS SUB TOTAL ABOVE.</b>	<b>-\$56.79</b>
<b><u>Total :</u></b>	<b><u>\$3,886.00</u></b>

**INVESTMENT ACCOUNT:**

Investment @ 1 Jul 18	\$9,135.91
Investment account interest	\$263.04
<b><u>BALANCE:</u></b>	<b><u>\$9,398.95</u></b>

**At Bank as at 30 Jun 2019**

BOQ Investment Account:	\$9,398.95
BOQ Cheque Account:	\$3,886.00

**Available Member Funds:** **\$13,284.95**

*I declare that the above statement presents a true and proper record of the income and expenditure of the Djinnang Association (QLD) and is an accurate record of the financial position of the Association as at the 30th June 2019.*

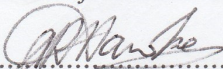
  
.....30 Jun 2019  
Alyn Hawkes (Treasurer)





**Betty Yardley @ Shirley Watson**



**Brian Webb @ Shirley Watson, worked together at Opcom**

**Part of the  
Crowd**







**Commops**



**Darwin foot trot ski club**



**Debbie Masters**

**The rest unknown**





**Denis @ Lew Jenkins, Nev Paten**



**Di Hoopet  
Trev  
Benneworth  
Ros Curran**



**Frank Rosa  
Jewels Townsend  
Debbie Banks  
Dave Grant**





**Glen Walton, Mick Holt, Ian Moorecroft,  
Basher Kirwin**

**Barbara Watson Diane Webb  
(Yes, Shane Watsons Mum)**

**2015 REUNION**



**Barb & Bob Bland, Robyn Russell  
John Isaacs**



**Con & Faye Chatham, John Goss  
Bob Spencer**



**Dianne Hooper, Noel Hartigan  
Carolyn Wilson, Nicola Hartigan**



**Dorothy & Col Cliff**





**Gail  
McDermott**

**Shane  
Buckley**



**Gavin Smith, Glen Walton, Wayne Dalmetias,  
Ros Smith**



**Gary Hagan  
Tony Ireland  
Swampy Marsh  
Sandy Matherson  
Mick Maloney**





**Glen Walton**  
**Gavin Smith**  
**Wayne**  
**Dalmeida**



**Grant Robertson @ Peta Brough**



**Hugh @**  
**Marion**  
**Barlow**



## RAAF closes AOCS

On 1 Dec 2004 the AOCS system was closed. The occasion was marked with a tour of Bringelly Receivers and Londonderry Transmitters where the CO RAAFTUS ceremonially cut the guy wires to drop the large antenna. Both establishments have now been decommissioned and you will soon be able to buy a one acre block of prime real estate on the Londonderry site.

The AOCS was commissioned in 1972 to take over from the Area Guard Network. The first operators at RAAF Sydney included Jeff Cullinane, Geoff Robinson, Ron Upham, Lyn Beilby, Bernie Mackay, George Harris, Ron Tompkins, Dave Corney and yours truly.

The system marked a quantum leap forward in communications technology for the RAAF and really earned it's spurs by providing instant voice and secure teletype communications immediately after cyclone Tracey devastated Darwin.

As usual there were the funny stories such as the RAF pilot questioning Charlie McMillan as to why he was operating RAAF Darwin and not RAF Dundee but this system was marked by the professionalism of those who operated and maintained it.

We live in times of rapid technological change and the RAAF we knew is no longer. We were told that Glenbrook has been sold and that the base is to be relocated to near Canberra in 2008. This will mark the end of an era which saw large numbers of communicators and techs stationed at Glenbrook, Marsden Park, Wallgrove, Bringelly and Londonderry.

Two things stood out to me during the closing ceremonies at Glenbrook: the large number of senior officers associated with the trade; and the lack of life on the base itself. Looking at the phone book they probably have a larger establishment than we did 30 years ago, but I don't think they have half the fun or camaraderie we enjoyed.

It was good to see the old base and more importantly a lot of old mates at the closure. Alison and I spent 12 years in Penrith and have a lot of happy memories of our time in the service there. On this occasion we stayed at the Airman's quarters and were the only people in our block. With unisex living quarters they would have been very popular in 1972. Can you imagine the "bed checks?"

Old hands among those who turned up on the day were; John Williams, Lyn Beilby, Rex Raph, Bill McCarthy, Don Brooks, John and Alison Cridland, Jeff Cullinane, Ian Greenacre, Mouse Graham, John O'Laughlan, Glen Walton and John Brell. On a sad note we received the news of Dave Corney's serious illness while there.

Current staff at Glenbrook under the direction of Doug Barthelson have a wonderful collection of old photos and mementos of the communications centres and people that have been stationed there. Looking at these reminded us of the stories that could be told of by our men and women who have passed through there. One story (the RAAF Penrith Football team) is retold in this edition. If you have a story to tell of your time here or during your RAAF service, please send it to [jcri2130@bigpond.com.net.au](mailto:jcri2130@bigpond.com.net.au) or John Cridland, 47 Ormond Rd, OXLEY 4075. I am sure there are some wonderful tales waiting to be told.



### DJINNANG ASSOCIATION SHIRTS

**These high quality shirts have been selling FAST, TO PURCHASE ONE, CONTACT ALYN Hawkes ([andhawkes@bigpond.com](mailto:andhawkes@bigpond.com)) and he will take care of the purchase and mailing for you.**

**Cost \$35.00 Plus postage**

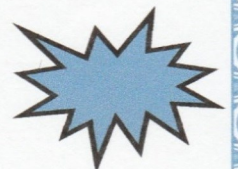





**Jules Townsend @ Debi Banks**



**Karen Downs  
Karren Brown  
Debra Doig**

**John O'Loughlan, Reg Wilson, Bob Tonk**



**John Cridland**







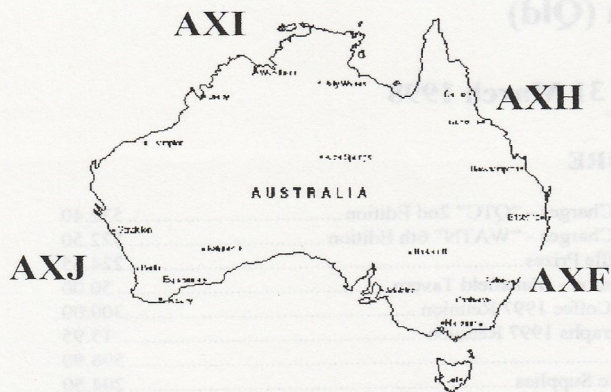

# AREA GUARD

**DO YOU REMEMBER VERY MUCH ABOUT "AREA GUARD"?** Besides the checks at 0030z each day.

Well, it would seem that not many of us can recall anything at all. Or is it that we are frightened to put our memories into words? One incident I recall was in 1957 when 2 Neptunes from 11 Squadron Richmond were positioned in Darwin in lieu of the 10 Squadron Lincoln from Townsville. It was arranged that whilst they were doing exercises in the Darwin area Telegs would exchange places with Signallers and relay "dummy" messages back and forth by morse. The operating went OK but when the pilot (a USAF exchange pilot) starting chasing buffalos at tree-top level down near Katherine and then flying just above the water of Darwin harbour to drop supplies to the crew of the other Neptune who were in liferafts was a bit much and I stepped off that aircraft on very shaky legs. Another instance that comes to mind was when, in the early 60's, a 24 hour watch was kept and we had to Tx & Rx "dummy" messages in 4 letter code. When some operators started sending messages like "IMGO INGT OTHE BOOZ ERTO NIGH TXZX" and were caught out by somebody at OPCOM, Steve Knight, as Supervisor of Lee Point, was not very happy - Was he Roy? The following was submitted by John Elliott:

"Let me relate a Story about Area guard.

This happened one Sunday at Lee Point Receivers at Darwin. Although I had left the Airforce by this time (early 70's) I was working as a Flight Service Officer at Darwin airport and also serving in the Airforce Emergency force so I got both sides of the story.

It was around 2pm in the afternoon and we received a call from the crew of a Herc enroute from Sydney to Darwin. Problem was that he could not contact Area guard to organise some food and gasoline for a quick turnaround on their way to Butterworth.

He requested that we contact the Orderly RAAF officer and get him to organise the above. I enquired if he had comms problems, no was the reply, although he could hear transmissions from area guard he could not get through and though it might be a stuck mic at Lee Point.

It seems (it actually happened), that the orderly officer after organising the turnaround took it upon himself to pay a surprise visit to Lee Point receiving station.

Now the rule was at Lee Point on weekends (I learn this when I did my AFEF time as a teleg at Lee Point), that you locked the outside gate to the facilities and if you had a visitor they had to ring the bell (used the phone ?), which alerted you to, hide the beer, clear up the playboy magazines, put away the playing cards and conduct a quick panic of the kitchen. UNFORTUNATELY, on this Sunday, some body had forgotten to lock the gate and the Orderly officer waltzed right in without an invitation and what he found displeased him greatly. What had happened was the unit dog had fallen asleep on the foot switch that was used to activate the mic on the area guard transmitter, which accounted for the continuous voices "Six no trumps and gettusa coldie while you are up".

My memory dimms around about here but if Percy Le - Que or Wally Muxworthy were still around they might be able to add to the story, but roughly it goes like this . Somebody got 14 days CB, the corporal got very upset with the LAC and the LAC severely chastised the dog."

**Are You**

**FINANCIAL?**

The Printing, postage etc. of 2 publications per year takes a vast amount of our finances. A large number of members have allowed their membership to lapse whilst still receiving our publications. *Please!* Help us to be able to continue to keep all informed by renewing your membership **TODAY!**

You may send your cheque/Money Order (payable to Djinnang Assn.) to the Treasurer

**Membership is \$10.00 per annum**





**Karen brown, Libby Brown, JanetteDekuyer, Keely Coppock**



**Keely  
Coppock  
Jannettee  
Dekuyer**



**Kerry  
Harrington,  
Les Coxhedge,  
Ernie Gimm,  
John  
McCormack,  
Denis Greig**





**Glenbrook  
Comcen**

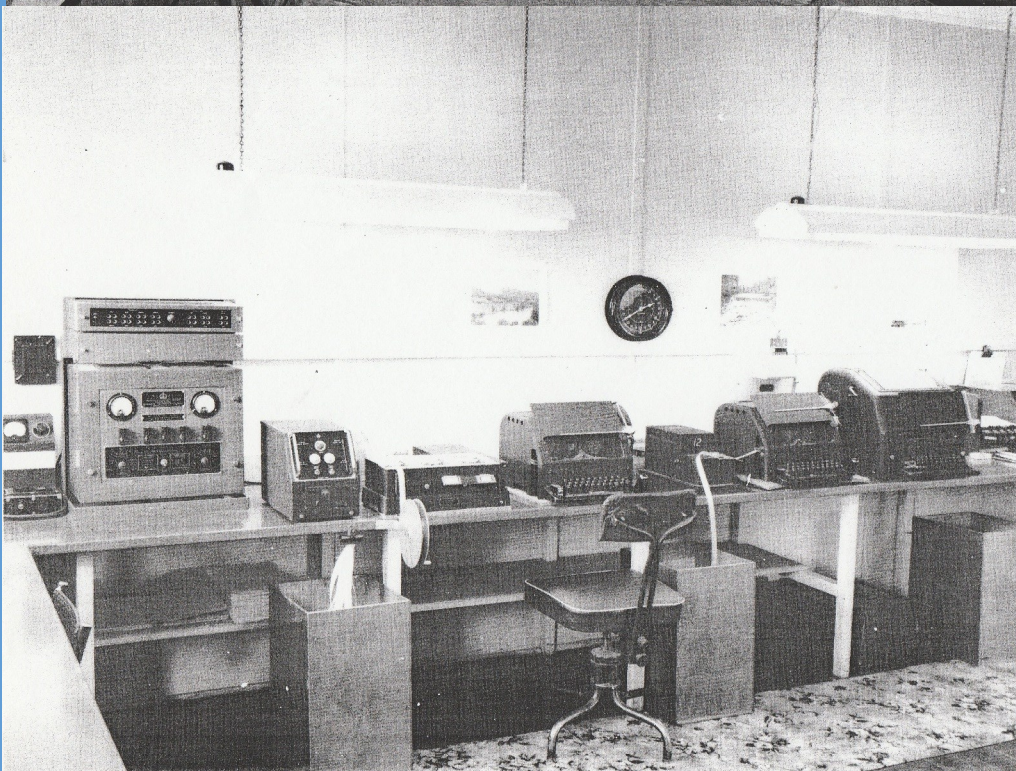

**East Sale  
Comcen**



**Amberley  
Comcen**



## *Who was the Telegraphist*

As a young lad I was fascinated by morse and could stand and watch my uncle send and receive telegrams for hours. Later on as a postal clerk in Cloncurry I was still jealous of the magic the telegraphist had as they spoke to outstations such as Normanton when the wet took the landlines down. One of the compelling reasons to join the RAAF was to learn Morse. I wasn't smart enough to reason that if the PMG had done away with it, then the service would follow shortly.

Sitting here producing this on the latest in PC technology, it is easy to forget that less than a lifetime ago, the quickest means of message communication was morse code, and that at the end of the second world war, long distance aircraft still required the services of both a competent navigator and wireless operator to ensure they arrived safe and sound. Even though some still recall riding horses to school, most of us forget the huge technological changes during our lifetime. In the last few years, I have become aware of the contribution of members of this association to this progress. By accident, I attended a function at QUT when a presentation was made to a former radio officer for "Contribution to Information Technology". At the function his exploits in WWII in intercepting and deciphering the Japanese codes were highlighted. I had known the person concerned when I was serving but had no idea of just how distinguished his career had been. Recently a serving member sought information about the defunct communications trades and again I realised how little I knew and how interested others are in knowing what we did. I solved the latter problem by twisting the arm of one of our senior members to respond. This magazine is always looking for your stories so that we can record your achievements. The following is the reply to the question, who was the Telegraphist?

Firstly the telegraphist training phase in my time was carried out at School of Radio at Ballarat. Prior to this, training was carried out at Point Cook and later again moved to Laverton after the closure of Ballarat. A pass at the conclusion of training was the ability to send and receive by hand, morse code at a speed of no less than 22 words per minute. Never the less a move towards greater speeds was demanded.

During WWII some of the terminals used high speed morse (HSM) between distant and overseas terminals. The morse was sent and received by mechanical means and speeds in excess of 100 wpm were practical in good conditions. Reception was on recorders which were then slowed down and read at hand speed.

In busier communication centres telegraphists were assisted by signals clerks, who headed and distributed individual messages. Cypher operators also had the responsibility to encrypt and decrypt classified texts for either distribution or on-forwarding for further transmission. As time went on teleprinter operators were used in conjunction with telegraphists on keyboard circuits. Multi channel radio circuits required constant attention and circuit control sections (CCS) were established and staffed by telegraphists and radio or telecommunications techs.

High Frequency Direction Finding stations were established at strategic points to maintain communications with aircraft and assist in navigation. Telegs who had been operator mechanics (WOMS) later became Telstechs, operating the HDF stations. These together with Area Guard stations and early Lincoln bombers played a huge role in obtaining knowledge of what we now know as jet streams, and pioneering international air routes after WW2. One of these HFDF stations on a remote part of the WA Coast serviced aircraft en-route Sydney/London via Colombo. When asked why they stayed at the remote station they coined the slogan "We stay because Qantas Wantus.

Other duties for Telegs were, operating point to point circuits, air ground air operations, shore ship links, area guard, weather broadcasts, aeradio (DCA) or OTC nets.



### International Morse Code

- 1 dash = 3 dots.
- The space between parts of the same letter = 1 dot.
- The space between letters = 3 dots.
- The space between words = 7 dots.

A	· —	V	· · — —
B	— · · ·	W	— · — —
C	— · — ·	X	— · — ·
D	— · · ·	Y	— · — · —
E	·	Z	— — · ·
F	· · —	.	· · · · ·
G	— · —	?	· · — · —
H	· · · ·	/	· — · —
I	· ·	@	· — · —
J	· — ·	1	· — — —
K	— · —	2	· — — —
L	— · — ·	3	· — — —
M	— —	4	· — — —
N	— ·	5	· — — —
O	— —	6	· — — —
P	— · — ·	7	· — — —
Q	— — · —	8	· — — —
R	· — — ·	9	· — — —
S	· — · —	0	— — — —
T	— · —		
U	— · — ·		
V	· · — —		
W	— · — —		
X	— · — ·		
Y	— · — · —		
Z	— — · ·		
.	· · · · ·		
?	· · — · —		
/	· — · —		
@	· — · —		
1	· — — —		
2	· — — —		
3	· — — —		
4	· — — —		
5	· — — —		
6	· — — —		
7	· — — —		
8	· — — —		
9	· — — —		
0	— — — —		

### phonetic alphabet

<b>A</b> alpha	<b>B</b> bravo	<b>C</b> charlie
<b>D</b> delta	<b>E</b> echo	<b>F</b> foxtrot
<b>G</b> golf	<b>H</b> hotel	
<b>I</b> india	<b>J</b> juliett	<b>K</b> kilo
<b>L</b> lima	<b>M</b> mike	
<b>N</b> november	<b>O</b> oscar	<b>P</b> papa
<b>Q</b> quebec	<b>R</b> romeo	
<b>S</b> sierra	<b>T</b> tango	<b>U</b> uniform
<b>V</b> victor	<b>W</b> whiskey	
<b>X</b> xray	<b>Y</b> yankee	<b>Z</b> zulu

With this NATO alphabet chart you will no longer use "M as in Mancy" during a support call with your mom, or while defusing a bomb.



### Combination of old Communication Equipment, Codes and Tape

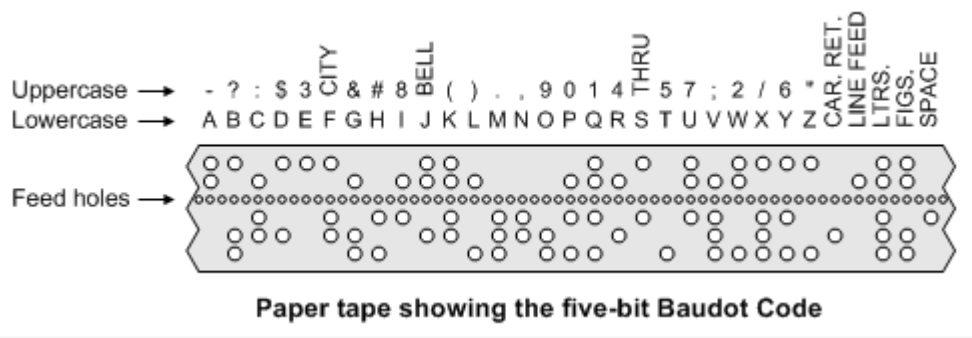





**Brian Webb, Des Williams, Ray Graham, John O'Loughlan, Ken Perkins.  
Ron Faulkner**



**17 Commops**



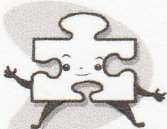

# BRAIN FOOD PAGE



## Cross out the words

D O T E A S T S A L E W O F F K  
 A V I P R D I Q S A J 3 C R U E  
 R I C H M O N D S V C T E X T Y  
 W Q K Q S P D I T E L E T Y P E  
 I R P S E C A C E R N L O F E D  
 N K O U N O L C L T N U W A A I  
 H A I P D M P P E O A X N I R N  
 O N N C C S L X N I G S R C B  
 N A T O O G B E E B R T V B E U  
 G X A M O R S E C O D E I A I R  
 K H R S K S U P R H A L L I O G  
 O W A G G A T O O L S U L N C H  
 N I D S D R F I F E H A E Z B O  
 G T S G T M A N A M B E R L E Y

- |           |                |             |
|-----------|----------------|-------------|
| AIR       | HQSUPCOM       | SVC         |
| FORCE     | KEYED          | SEND        |
| AMBERLEY  | LEE POINT      | SGT         |
| ARMS      | LAVERTON       | TEXT        |
| AC        | LAC            | TINDAL      |
| AIRTELU   | MARSDEN        | TOWNSVILLE  |
| AXH       | MORSECODE      | TELETYPE    |
| AXN       | MSG            | TELEX       |
| ARMY      | OPCOM          | WOFF        |
| BOHLE     | PEARCE         | WAGGA       |
| CPL       | POINT          | WILLIAMTOWN |
| COPY      | COOK           | RADSCL      |
| DARWIN    | <del>PSS</del> | VIP         |
| DSD       | QSA            | 3CRU        |
| DOT       | QRK            | 3TELU       |
| DASH      | QRX            | ZBO         |
| EAST SALE | RAFTUS         |             |
| EDINBURGH | RICHMOND       |             |
| FAIRBAIRN |                |             |
| HONG KONG |                |             |

Crack the Code

A	2	25	7	21	8	12	18	7	16	17	10				N
B	3	8	8	8	21	21	8	8	17						O
C	5	23	18	21	12	2	23	8	24	21	8				P
D	20	14	8	19	2	22	1	17	18						Q
E	1	17	17	18				16	8	18	21				R
F	19	22	7	21	5	16		17	11	8	2	5			S
G		17			25	8	18			11					T
H		15	15	17	19		23	9	6	8	4				U
I		14			5	10	4			5					V
J	8	3	22	25	25	21		8	12	15	2	4			W
K							26	8	12	21	12				X
L	8	23	23	17						11	21	12	4		Y
M	8	17	16	17	8	14	21			21		2			Z
	1	17	6	18	19	14		18	8	18	18	4			
	2	15	5	2	15	8		8		18					
	21	7	20	17		1	4	21		25	2	21	13		

Letter Checker

1	2	3	4	5	6	7	8	9	10	11	12	13
C												
14	15	16	17	18	19	20	21	22	23	24	25	26
G	R											

Can you fill these numbers into the grid? One number has been inserted to help you get started.

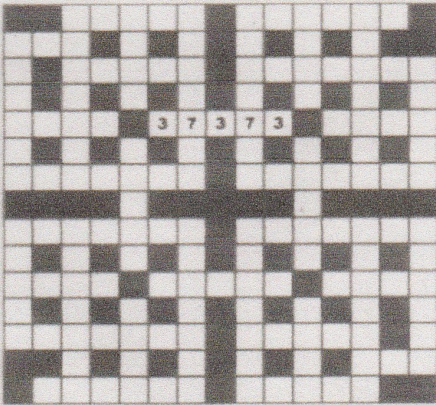

<b>3-FIGURE NUMBERS</b> 493 539	<b>5-FIGURE NUMBERS</b> 16741 20829 24393 27997	<b>6-FIGURE NUMBERS</b> 191053 590775 61252 837701
<b>4-FIGURE NUMBERS</b> 1491 2904 5863 5941 6474 7821 8727 9217	<b>5-FIGURE NUMBERS</b> 40758 46227 47608 75354 90243	<b>7-FIGURE NUMBERS</b> 1809043 3804214 4365471 4792944 4917285 5164728 5753765
		<b>6-FIGURE NUMBERS</b> 6284787 7024287 7342818 7892421 8098604 8319745 9215944

Here's Freddie Fisher, sitting on the bank of the River Catchmore, dreaming of the fish he'll hook. Can you divide his thoughts opposite by drawing two straight lines to produce three sections, each containing four small fish, three medium fish and two large fish?

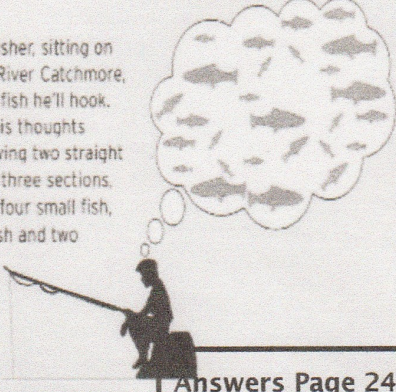

Answers Page 24





**Aunty Joy**



**Aunty Joy, Wendy Matherson**



**Association Dress shirts**

**There are still shirts available**

**Costs \$35.00**

**Contact Alwyn Hawkes**

**Email [andhawkes@bigpond.com](mailto:andhawkes@bigpond.com)**

**To order one, be quick they are**

**Going fast and look Fantastic**



**SUNDOWNER TIONA TOURIST PARK**  
**4451 The Lakes Way Pacific Palms NSW 2428**  
**0265540291**

**Also an offer.**

**My wife and I are now the permanent managers of a holiday facility just south of Forster Tuncurry on the lakes way. It's an older facility but there is an enormous amount of money being spent to get it back up to speed.**

**Some things about this place that might be of interest to you and any association members:**

**We have beach frontage 150 meters from our cabins.**

**On the other side of the park we have lake frontage 150 meters from our office (Lake Wallis).**

**We have 20 dual room cabins most with full facilities.**

**We have a lodge facility that beds up to 80 people with full amenities and its own commercial kitchen facility.**

**We have a function centre that regularly caters for up to 150 people for events with its own commercial kitchen.**

**We have 100 powered camping/caravan sites \$29.00 per site at present.**

**We even have our own open air chapel where many weddings are held - not that I use it, keep getting zapped when I go there.**

**So the offer is if any member rings up on an individual basis and identifies themselves as an association member they will get a 15 percent discount on any accommodation.**

**Additionally if you were interested in holding an event here then put together a deputation, give us a bit of notice, come and visit and have a look around. We will provide free accommodation for a couple of nights free.**

**We're in control of the purse strings so we'll make sure of a good deal if you are interested in a function.**

**regards, Clive**

**Clive & Karen Johnson.**

**Work Phone 02 65540290**

**Mobile 0419889584 (Doesn't work so well in park).**

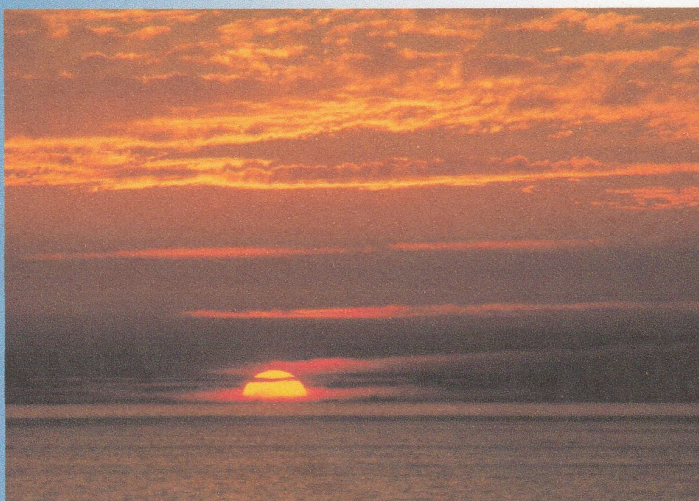





**1—93 ciscon**



**1—03 Ciscon**



**2—02 Ciscon**





**2—03 Ciscon**



**2—93 Ciscon**



**3—95 Ciscon**





**5—02 Ciskon**



**Trinops  
2019**



**Telstek  
2019**





AUSTRALIAN WAR MEMORIAL

VIC1482

## **The WRAAF of the late 40's—early 50's**



AUSTRALIAN WAR MEMORIAL

VIC1481





**3—02 Ciscon**



**3—93 Ciscon**



**4—93 Ciscon**



## The RAAF Penrith Football Team

Have announced that they will be attending the 2006 re-union after the good time they had at the 2004 do. Back in 1972 the small base at Penrith provided an outstanding Rugby League team which played in the very strong Penrith Junior District competition. Nominated as the reserve grade side for the much larger Richmond RAAF base team, it did not take the opposition long to work out that their reserve teams could whip the RAAF senior side, while their A Grade sides were usually beaten by the junior side. In 1972 this team beat a side from the powerful Windsor club to win the premiership. In 1973 playing correctly as the A Grade side, they were beaten by Blacktown Brothers in the grand final.

It is unusual for a service team to do well in a domestic competition as the demands of service life do not allow for a stable team. This club had nearly two sides. A week before the 1972 final the club was wracked when more than half their members were posted to Darwin. Only the intervention of a Wing Commander who had been following their progress closely saw them able to play and win the flag on the day. After the 1973 final a number of their remaining talented players were posted to 3TU. They never had the numbers for a team in 1974.

As you would expect in a team from this base, our members were heavily represented with both the coach and captain being Telegs. Current president Lyn Beilby was a very good hooker in the 1972 side. The two coaches "Bull" Donald and Brian Carroll left their mark on the game as the fathers of current Manly star Scott Donald and retired international Mark "Spud" Carroll.





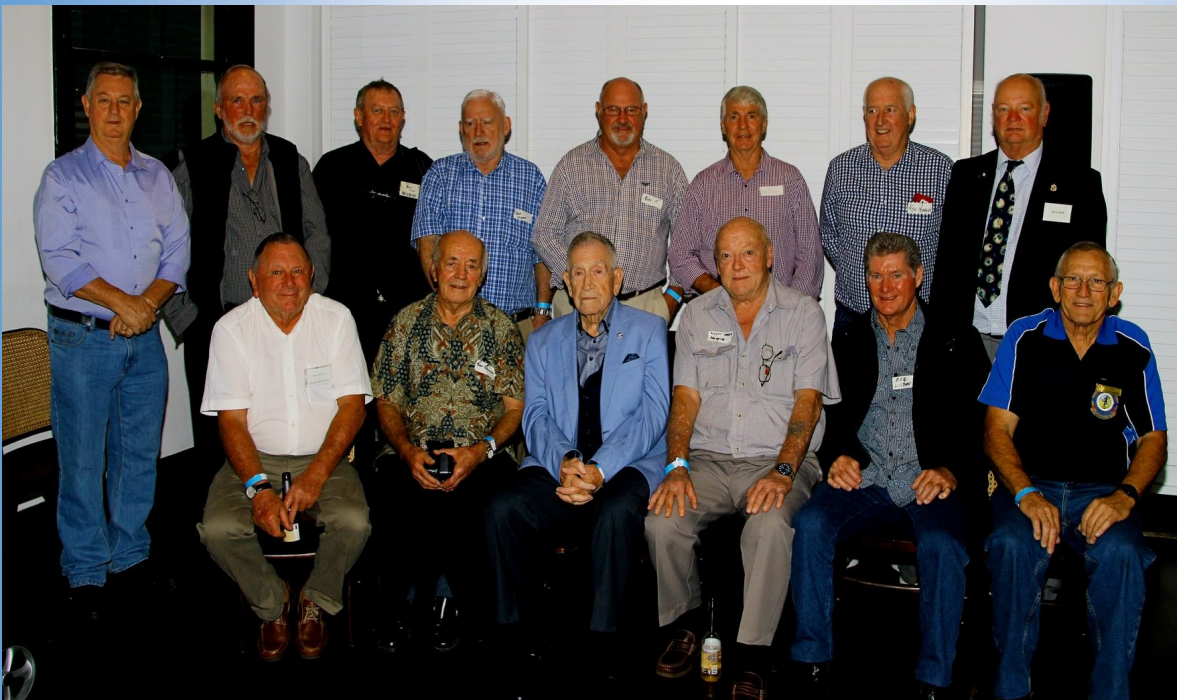

**Telegs  
@  
Sigops**



**Radteck**



**Some of  
The  
Motley  
Crew**





**Lisa  
Williams  
@  
Peta  
Brough**



**Liz  
Williams,  
Debbie  
Masters,  
Murray  
Crome,  
Debbie  
Kinsel,**



**Paul  
Cashman  
Colleen  
Jolley,  
Christine  
Cashman,  
Ros  
Smith,  
Carolyn  
Wilson.**





**Maree @  
John  
Findlay.**



**Mike  
Downs.**



**Nipper  
McGilvery,  
Jill  
McAndrews**





**Pygmy @  
Jill McAn-  
drews,  
Duncan @  
Heather  
Slaven,  
Col @ Marie  
Price.**



**Robyn  
Curran,  
John Isaacs.**



**Ron Amos  
Ron Bellert**





**Ron  
Bellert  
(Life  
Member-  
ship)**



**Ros  
Curran,  
Marie  
Andersen.**



**Ros  
Curran,  
Joy  
McPherson,  
Marie  
Henson,  
Di Hoppert**





**Ros  
Smith,  
Libby  
Brown.**



**Shelley  
Mathers,  
Sue  
Colly.**



**Part of  
The Crew**



# RAAF COMMUNICATIONS REUNION

**2020**

Hi everyone,

Those of you that don't live in the Brisbane region may not know that the Hotel Jen will be closing its doors at the end of 2018 (sigh!) and we have had to find yet another new venue for our reunion. Such a shame as it was pretty near perfect for us. You can thank the Government for this decision.



not know  
2018  
ue for our  
for us.

It has been decided that **The Port Office Hotel (Colonial Bar)** is the new place to be on **30th May 2020**. The address is 40 Edward Street (Cnr. Margaret St) Brisbane City. While the Colonial Bar is upstairs – there is also a small lift for those requiring it. You just have to ask one of the staff members to escort you to the lift.

The normal function times apply – 2pm till 9pm. There will be a free drink on arrival and platters as per the last few reunions. Entry will remain the same price as last year - \$30 non-perpetual members and \$20 perpetual members.

We have a code that can be used at any of the Oaks CBD apartments, 212 Margaret Street (just up the road from the Port Office). I am not sure how much discount we will get. The code is [portofficehotel](http://portofficehotel.com.au). They have a car park here I believe. If you want a 5 Star Hotel the Stamford Plaza is directly across the road from the Port Office. Also, opposite the old Botanical Gardens is 'Royal on the Park'. These are the three that are closest to the venue I think.

We also have a code for [secureparking.com.au](http://secureparking.com.au). I just tried a dummy booking and it took my cost from \$16 to \$9. You must be out by midnight though I think. There are special instructions which I will share closer to the time of the reunion.

Unfortunately, there won't be a coffee/tea station in the Colonial Bar on the night, but these can be purchased from their Restaurant downstairs. Dinner can also be purchased downstairs.

Hoping to see you all there on the night to again reminisce and have a few drinkies. Please spread the word regarding the change in venue.

Gail McDermott

Djinnang Association (Secretary)





**2020 REUNION**  
**SATURDAY 30TH MAY**  
**2PM—9PM**

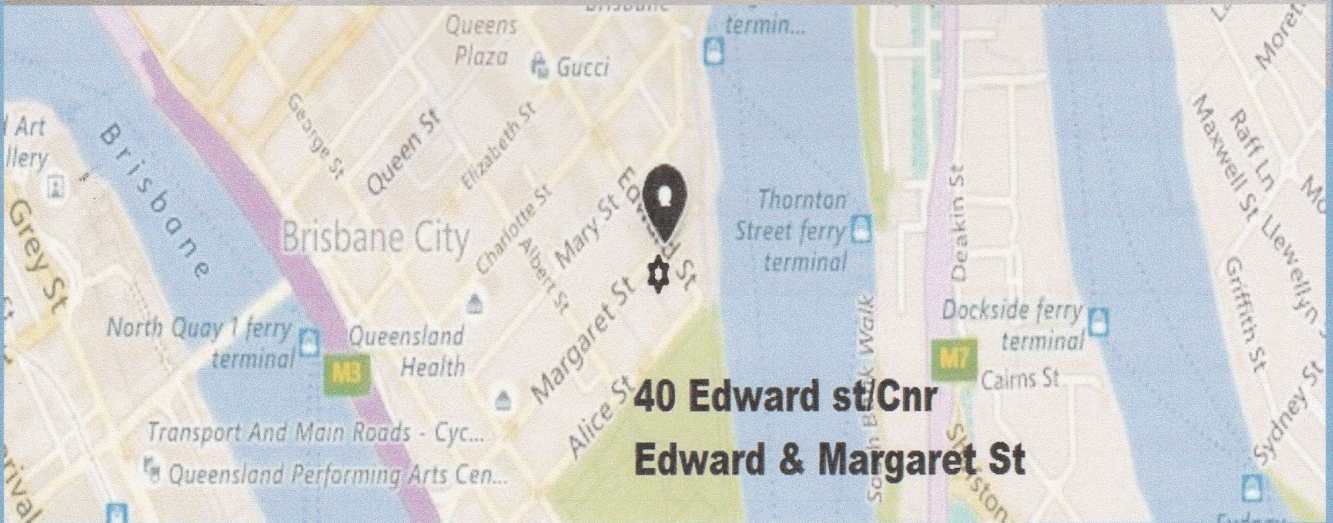
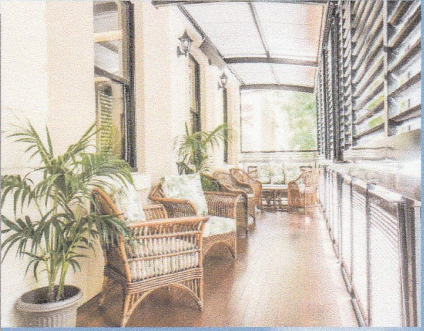

**More Information on the Port Hotel (Accommodation/Parking) Etc on Previous Page.**